

# Unison Series

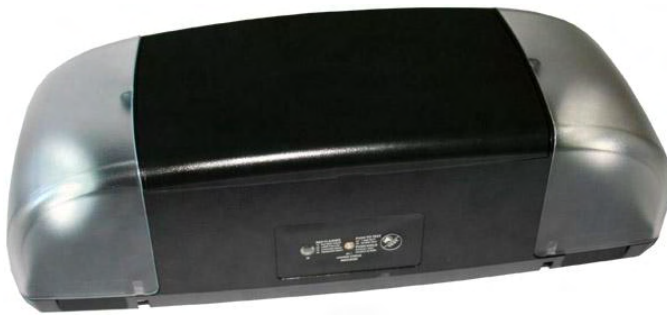

Commercial Emergency Lighting



# Engineered Compliance

- UL 924 Listed
- UL Damp Location listing  
Optional 0 to 40 C
- Exceeds NEC, IBC, NFPA  
requirements for emergency  
lighting



# Product Overview

## Product Configurations

- 6-VDC models
  - 18 to 72-watt Lead
  - 25 and 50-watt nicad
- 12-VDC models
  - 36 to 72-watt Lead
  - 25 and 50-watt nicad



# Product Overview

## Housing

- UV stabilized Lexan® material
- One-piece injection-molded housing
- Removable, hinged door
- Removable lenses



# Product Overview

## Housing

- 1/2" flex conduit knockout

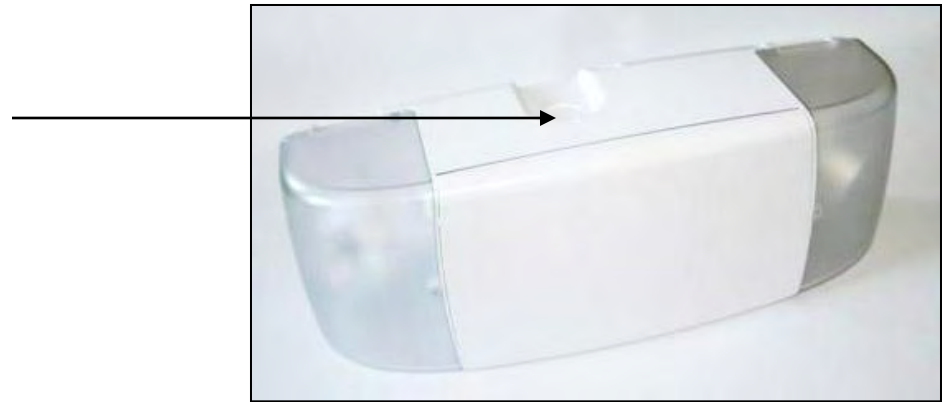

# Product Overview

## Housing

- Universal j-box knockout pattern

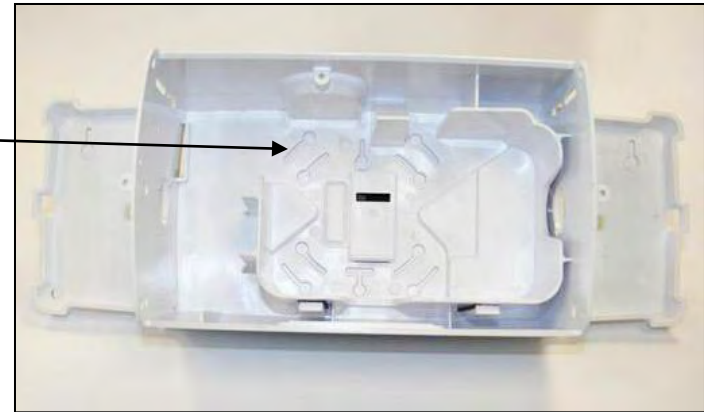

# Product Overview

## Housing

- Key-hole slot knockouts provide additional mechanical support when desired

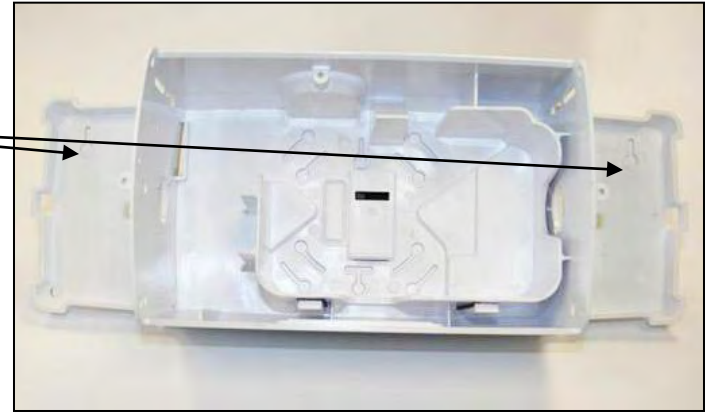

# Product Overview

## Lamp Head Assemblies

- Halogen bi-pin or MR16
- 6-volt, 6 to 12-watt
- 12-volt, 12 to 20-watt
- High-temp Ultem® material with ceramic lamp base
- Complete horizontal and vertical adjustment



# Product Overview

## Electrical/Mechanical

- Quick connect harness
  - Input power
  - Battery to charger

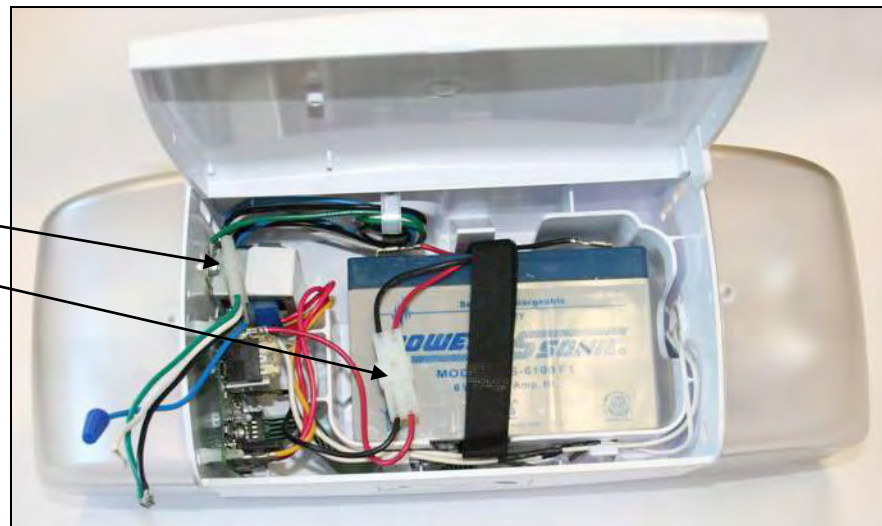

# Product Overview

## Electrical/Mechanical

- Integral door stop

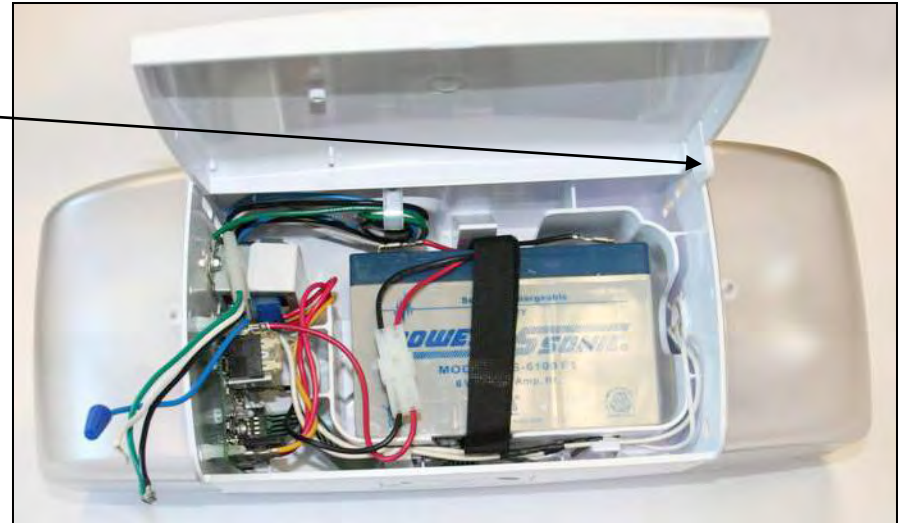

# Product Overview

## Electronics

- Smart Charger Diagnostics
- On-board IR receiver
- SCIR user remote (optional)

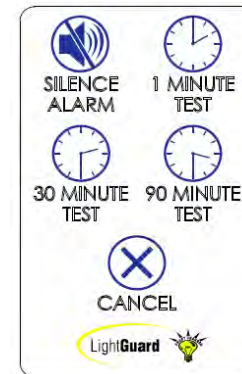
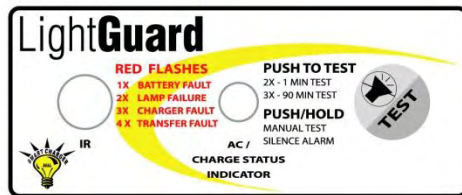

# Electronics

## Smart Charger

- Microprocessor driven
- Temperature compensated
- Standard diagnostics



# Electronics

## Standard Features

- Transformer isolated input
- AC power indicator
- Charge status indicator
- Visual fault indicator
- Audible user interface
- On-board IR receiver



# Electronics

## Standard Features

- AC lockout mode (Ac line latch)
- Brownout protection
- Low-voltage battery disconnect (LVD)
- Temperature compensated charger equal to 3mv/C
- Reverse polarity detection (battery)

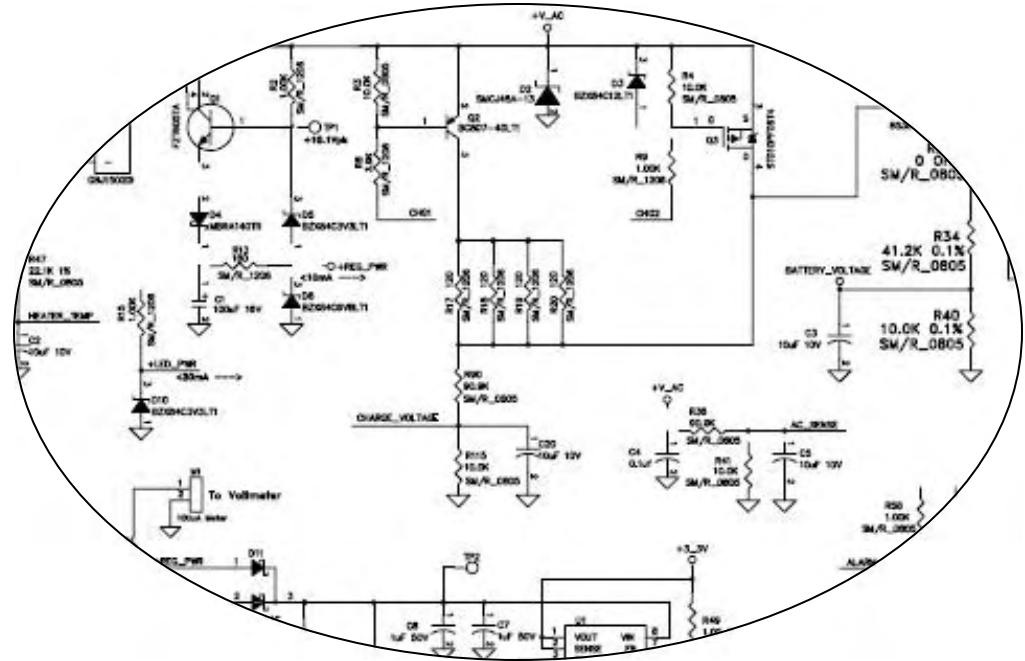

# Electronics

## Standard Diagnostics

Continuous, real-time monitoring

- Battery fault
- Battery disconnect
- Charger fault
- Load loss detection (10%)
- Transfer fault

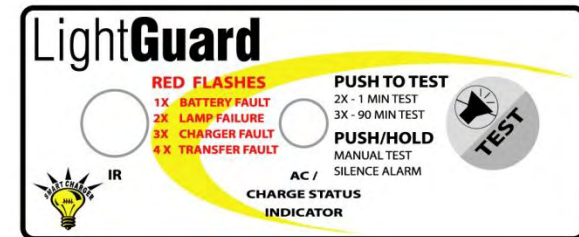

# Project Versatility

## Factory Options

- Self-testing
  - Non-audible
  - Audible
- Time delay
- Voltmeter
- Ammeter
- AC input fuse
- AC disconnect switch
- Battery disconnect switch

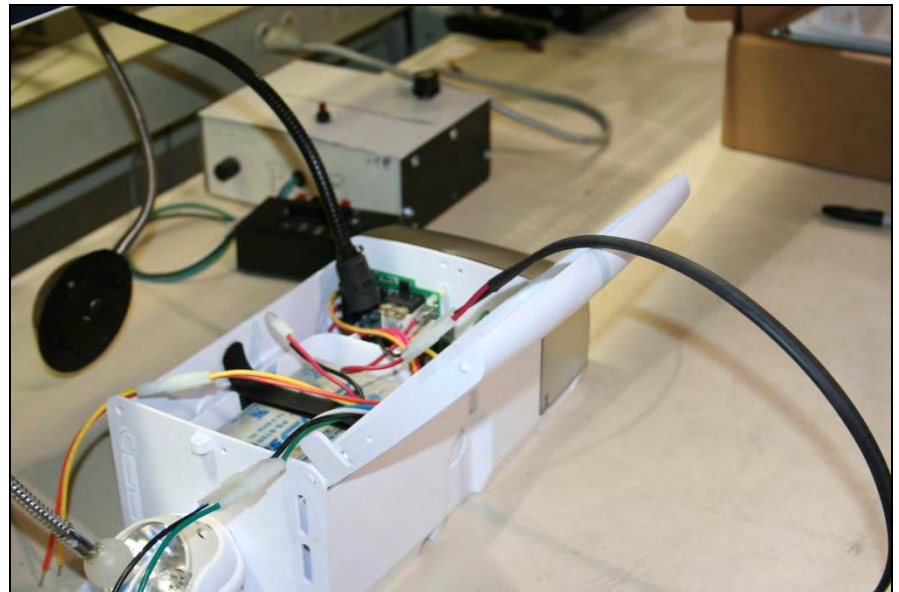

# Product Accessories

## Mounting Accessory

- Optional mounting kit for columns, poles & I-beams

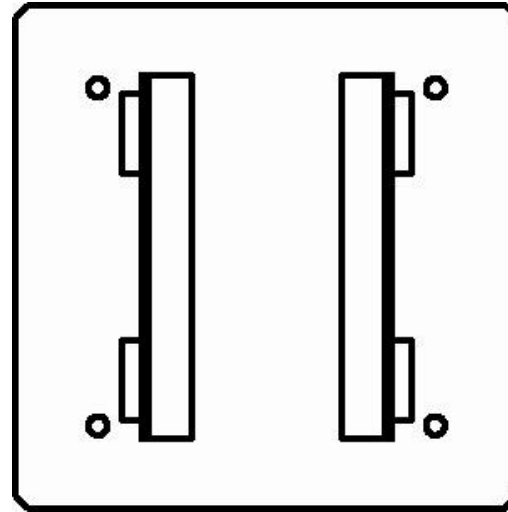

# Product Accessories

## Remote Heads

- White or black mounting plate and heads
- 6-VDC
  - 6 to 12-watt bi-pin halogen
- 12-VDC
  - 12 and 20-watt bi-pin and MR16 halogen



# Product Accessories

## Remote Test Device

- Activate required monthly and annual testing remotely.

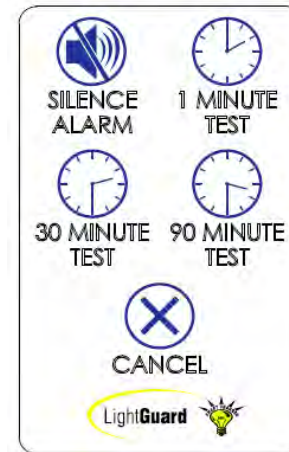

# Unison Product Mix



## 6-Volt Unison

- Lead Calcium
  - 12 or 18-watts
- Nickel Cadmium
  - 12, 14 & 18-watts
- White or Black housing



## 6 & 12-Volt Unison

- Lead Calcium
  - 18, 25, 36, 50 & 72-watts
- Nickel Cadmium
  - 25 & 50-watts
- White or black housing
- Smart Charger Diagnostics
- Factory Installed Options
- Remote test capabilities

# Unison When to Use



**6-Volt Unison**



**6 & 12-Volt Unison**

Made In the US	X	X
Nickel Cadmium	X	X
Lead Calcium	X	X
Diagnostics		X
Damp Location		X
Remote test capabilities		X
Factory installed options		X
Optional column/pole mount		X
Remote capacity		X
Extended run time		X