

SLB520/LTP520T

INSTALLATION INSTRUCTIONS

! IMPORTANT SAFEGUARDS !

WHEN USING ELECTRICAL EQUIPMENT, BASIC SAFETY PRECAUTIONS SHOULD ALWAYS BE FOLLOWED, INCLUDING THE FOLLOWING:

READ AND FOLLOW ALL SAFETY INSTRUCTIONS

1. To prevent high voltage from being present on red & yellow output leads prior to installation, inverter connector must be open. Do not join inverter connector until installation is complete and AC power is supplied to the emergency ballast.
2. This product is for use with one 21 through 54 W (2'- 4') T5 or 32 W (4') T8 fluorescent lamps.
3. Make sure all connections are in accordance with the National Electrical Code and any local regulations.
4. To reduce the risk of electric shock, disconnect both normal and emergency power supplies and inverter connector of the emergency ballast before servicing.
5. This emergency ballast is for factory or field installation in the ballast channel or on top of fixture.
6. This product is suitable for use in damp locations where the ambient temperature for fixture is 0°C minimum, +50°C maximum. Product is also suitable for installation in sealed and gasketed fixtures. Product is not suitable for heated air outlets and wet or hazardous locations.
7. An unswitched AC power source is required (120 or 277 VAC, 60 Hz).
8. Do not install near gas or electric heaters.
9. Do not attempt to service the battery. A sealed, no-maintenance battery is used that is not field replaceable. Contact the manufacturer for information on service.
10. The use of accessory equipment not recommended by the manufacturer may cause an unsafe condition.
11. Do not use this product for other than intended use.
12. Servicing should be performed by qualified service personnel.

SAVE THESE INSTRUCTIONS



CONTAINS NICKEL-CADMIUM
RECHARGEABLE BATTERY.
MUST BE RECYCLED OR
DISPOSED OF PROPERLY.



05/24/10

INSTALLATION



WARNING: TO PREVENT HIGH VOLTAGE FROM BEING PRESENT ON RED & YELLOW OUTPUT LEADS PRIOR TO INSTALLATION, INVERTER CONNECTOR MUST BE OPEN. DO NOT JOIN INVERTER CONNECTOR UNTIL INSTALLATION IS COMPLETE AND AC POWER IS SUPPLIED TO THE EMERGENCY BALLAST.

NOTE: Make sure that the necessary branch circuit wiring is available. An unswitched source of power is required. The emergency ballast must be fed from the same branch circuit as the AC ballast.

1. Disconnect AC power from the fixture. Remove the ballast channel cover and install the emergency ballast in the ballast channel (see Illustration 1).
2. Select the appropriate wiring diagram to connect the emergency ballast to the AC ballast and lamp. Make sure all connections are in accordance with the National Electrical Code and any local regulations.
3. Install the test switch through the ballast channel cover of a troffer. Drill a 1/2" hole and install the switch as shown (see Illustration 1). Wire the test switch so that it removes AC power from both the emergency ballast and the AC ballast at the same time (see wiring diagrams section of these instructions).
4. Refer to charging indicator light installation insert page and install the charging indicator light so that it will be visible after the fixture is installed.
5. In a readily visible location, attach the label "CAUTION— This Unit Has More Than One Power Connection Point. To Reduce The Risk Of Electric Shock, Disconnect Both The Branch Circuit-Breakers Or Fuses And Emergency Power Supplies Before Servicing."
6. After installation is complete, supply AC power to the emergency ballast and join the inverter connector.
7. A short-term discharge test may be conducted after the emergency ballast has been charging for one hour. Charge for 24 hours before conducting a long-term discharge test. Refer to OPERATION.

ILLUSTRATION 1

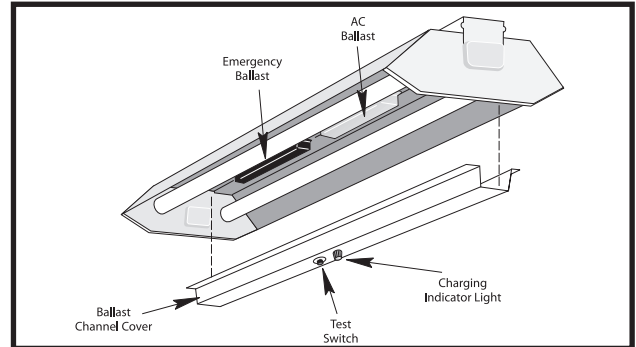

ILLUSTRATION 2

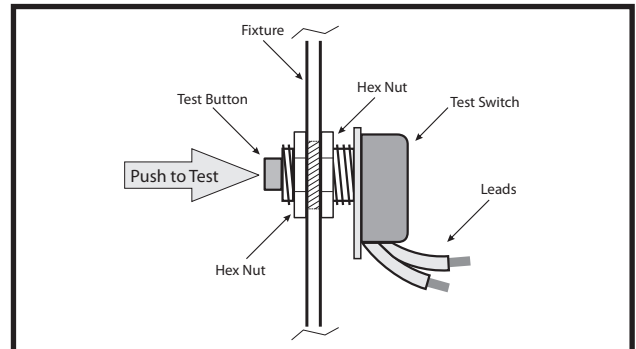

ILLUSTRATION 3A

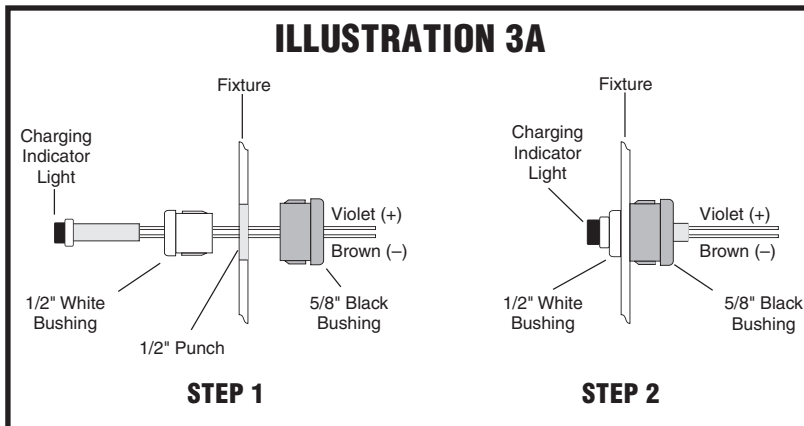
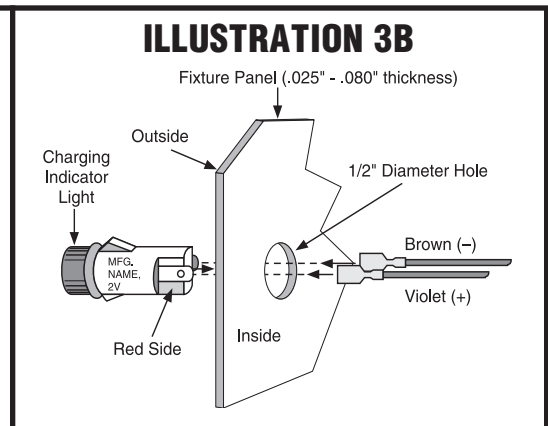

ILLUSTRATION 3B



NOTE: After installing the charging indicator light and test switch, mark each with the appropriate label. If a detached charging indicator light is used, connect by matching wire colors and install as shown on the installation insert page.

OPERATION

With AC power applied, the charging indicator light is illuminated, indicating that the battery is being charged. When power fails, the emergency ballast automatically switches to emergency power, operating one lamp at reduced illumination. When AC power is restored, the emergency ballast returns to the charging mode and delays AC ballast operation for approximately three (3) seconds to prevent false-tripping of AC ballast (end-of-lamp-life) shutdown circuits. This emergency ballast will operate one 21 through 54 W (2'- 4') T5 or 32 W (4') T8 lamp for a minimum of 90 minutes.

MAINTENANCE

Although no routine maintenance is required to keep the emergency ballast functional, it should be checked periodically to ensure that it is working. The following schedule is recommended:

1. Visually inspect the charging indicator light monthly. It should be illuminated.
2. Test the emergency operation of the fixture at 30-day intervals for a minimum of 30 seconds. One lamp should operate at reduced illumination.
3. Conduct a 90-minute discharge test once a year. One lamp should operate at reduced illumination for at least 90 minutes.

REFER ANY SERVICING INDICATED BY THESE CHECKS TO QUALIFIED PERSONNEL.

EMERGENCY BALLAST AND AC BALLAST MUST BE FED FROM THE SAME BRANCH CIRCUIT.

TYPICAL SCHEMATICS ONLY. MAY BE USED WITH OTHER BALLASTS. CONSULT THE FACTORY FOR OTHER WIRING DIAGRAMS.

WIRING DIAGRAMS for 1-LAMP emergency operation

FIG 99BH ONE (1) LAMP RAPID START BALLAST

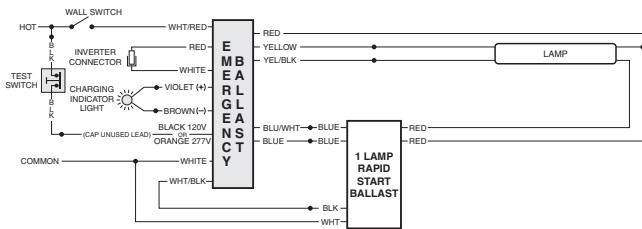

FIG 119BH ONE (1) LAMP INSTANT START BALLAST

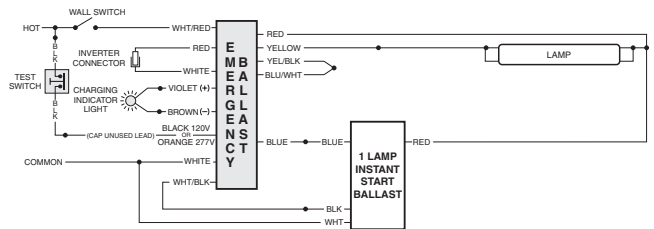

FIG 124BH TWO (2) LAMP RAPID START BALLAST

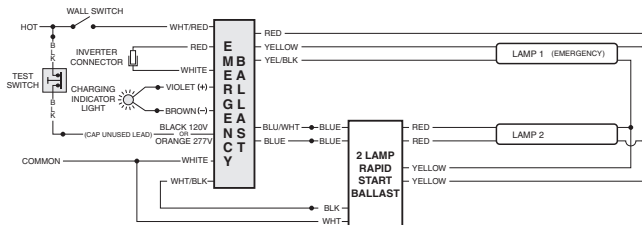
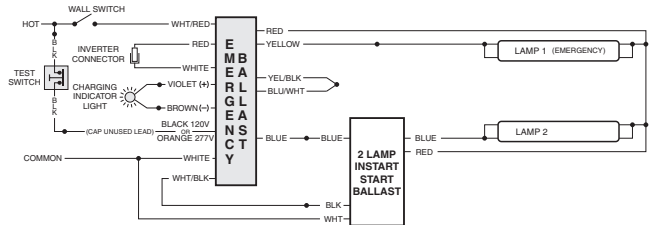

FIG 104BH TWO (2) LAMP INSTANT START BALLAST



EMERGENCY BALLAST AND AC BALLAST MUST BE FED FROM THE SAME BRANCH CIRCUIT.
 TYPICAL SCHEMATICS ONLY. MAY BE USED WITH OTHER BALLASTS. CONSULT THE FACTORY FOR OTHER WIRING DIAGRAMS.

WIRING DIAGRAMS for 1-LAMP emergency operation

FIG 105BH THREE (3) LAMP RAPID START BALLAST

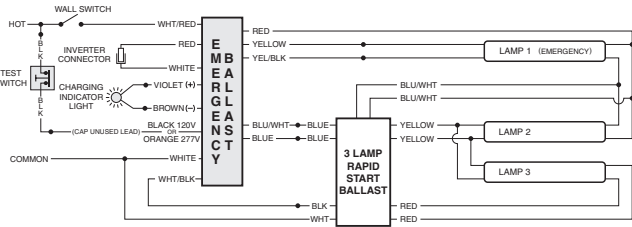

FIG 106 BH THREE (3) LAMP INSTANT START BALLAST

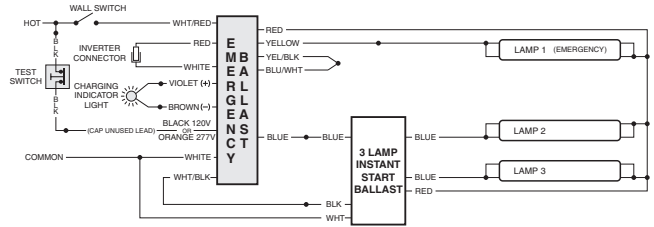

FIG 120BH FOUR (4) LAMP RAPID START BALLAST

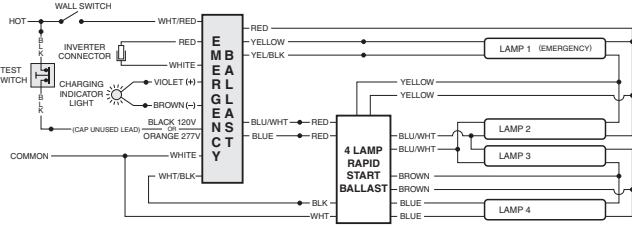

FIG 121BH FOUR (4) LAMP INSTANT START BALLAST

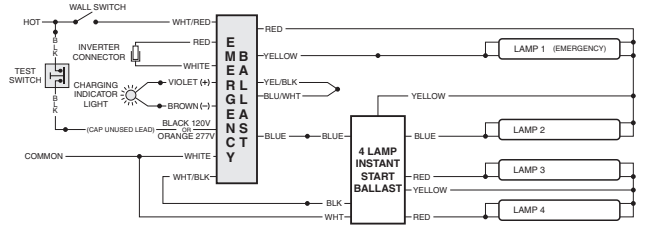

FIG 99aBH TWO (2) LAMP RAPID START BALLAST - SERIES YELLOW

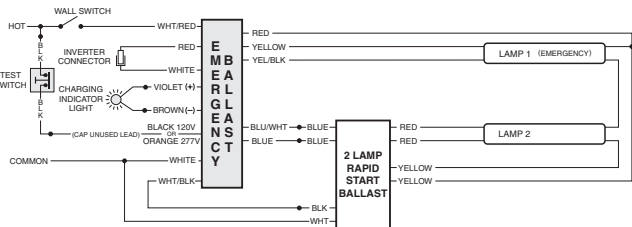

FIG 99bBH TWO (2) LAMP PROGRAM RAPID START OSRAM BALLAST

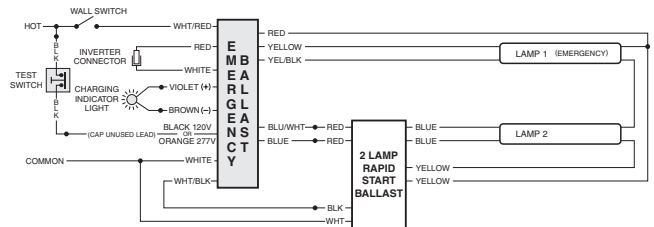

FIG 150BH FOUR (4) LAMP RAPID START BALLAST - SERIES

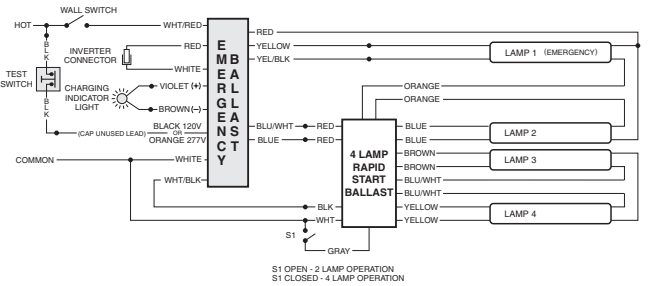
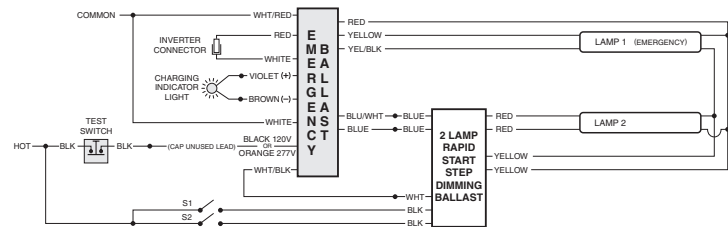

FIG 124BH TWO (2) LAMP RAPID START STEP DIMMING BALLAST



THE WHITE/BLACK LEAD MUST CONNECT TO THE WHITE LEAD OF THE STEP-DIMMING BALLAST ASSOCIATED WITH THE EMERGENCY BALLAST ONLY. CONNECTIONS TO OTHER BALLASTS OR FIXTURES COULD RESULT IN ABNORMAL OPERATION AND CAUSE PRODUCT DAMAGE.

WIRING DIAGRAMS for Emergency-Only fixtures

FIG 109BH ONE (1) 21 W - 54 W LAMP WITHOUT AC BALLAST

